

# AKW Denova Lever Bath Taps

## INSTALLATION INSTRUCTIONS

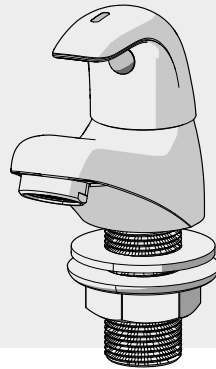
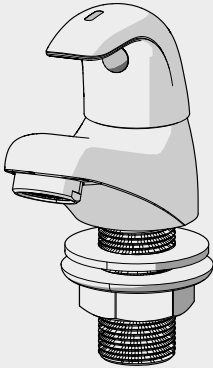

Please read all instructions before installation and leave this document with the end user for future reference as it contains important warranty information

## Dimensions and Parts

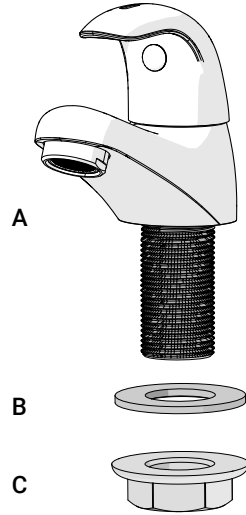
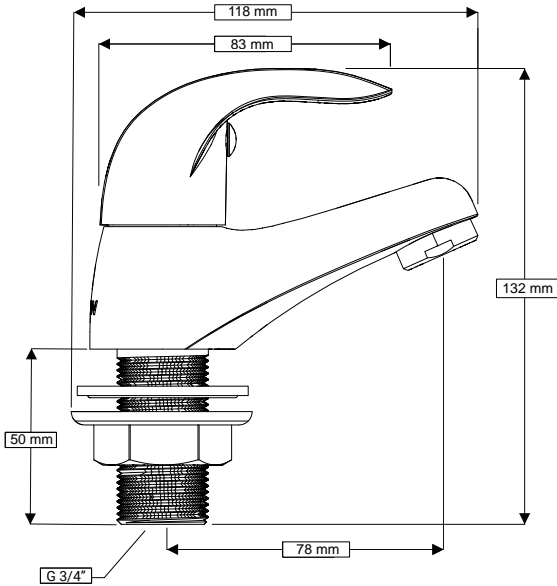

Parts		QTY
A	Tap	2
B	Washer	2
C	Nut	2

**Installation must be carried out in accordance with these instructions, and must be conducted by qualified and competent installer.**

This product must be installed in compliance with the Water Regulations. You may need to fit flow limiters to meet local requirements.

If you are unsure, please obtain the advice of a professional plumber before attempting any work.

**Note:** the hot tap indicated by the "red dot" and is normally fitted on the left when viewed from the front.

## Water Pressure

**These taps are suitable for low and high pressure systems.**

**These taps should not be used with pressures exceeding 5 Bar. Min Pressure 0.2bar.**

If the mains pressure is over 5bar, then a pressure reducing valve should be fitted. If the taps or mixers are installed to low pressure (tank fed), then the minimum height from the outlet of the nozzle to the underside of the cold tank should be 1.8 metres to ensure adequate performance.

**Important:** Access must be made available to the water supplies and fixings for future maintenance and servicing. Isolation valves must be fitted. Ensure that all parts are present and that you have the suitable tools and connections before installation. Flexi-Hoses are not supplied.

# Installation & Operation

**Warning!** Before installation, it is essential that you thoroughly flush through the supply pipes to remove any remaining swarf, solder or other impurities. Failure to do so could cause damage to the internal workings of the tap. AKW will not accept responsibility for any problems that occur through incorrect installation. ISOLATE THE WATER SUPPLY.

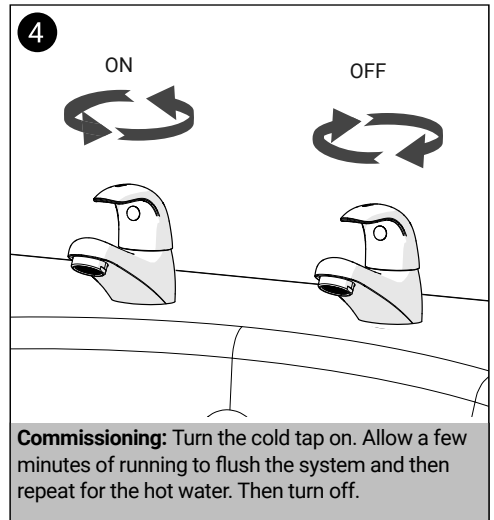
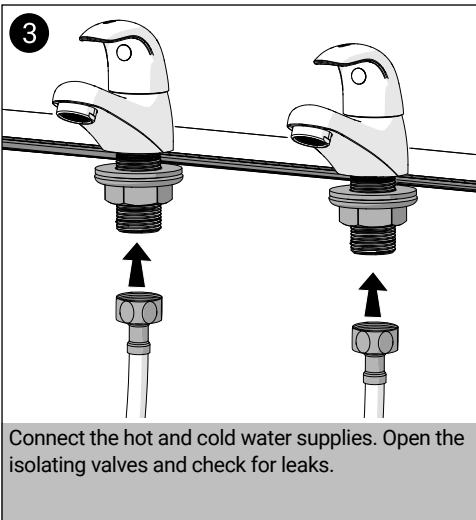
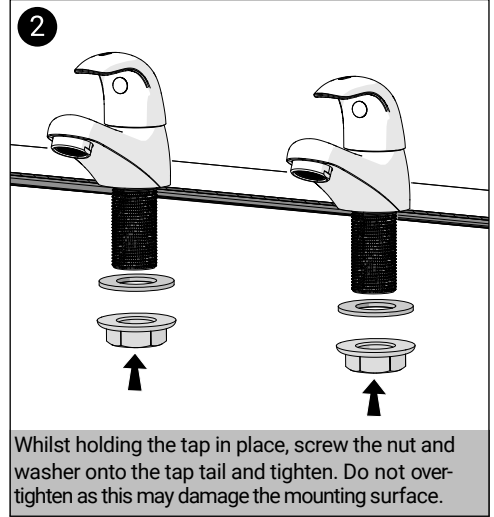
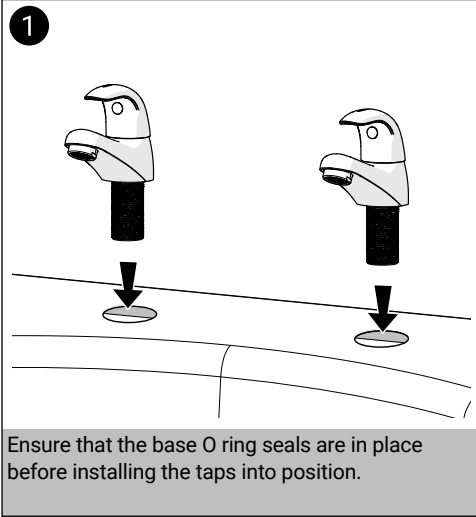

## Cleaning and Care

Taps should be cleaned as part of a planned maintenance programme. Do not use abrasive cleaning chemicals or scouring cloths as this will effect the surface finish. Always flush cleaning materials away with copious amounts of water and wipe down to dry.

# Contact

**AKW**<sup>®</sup>  
Life Made Better

## Orders & Quotes

01905 823 299  
orders@akw-ltd.co.uk

## General Enquiries

01905 823 298  
sales@akw-ltd.co.uk

## Technical Enquiries

01905 560 219  
technicalenquiries@akw-ltd.co.uk

## Kitchen Enquiries

01905 823 262  
kitchens@akw-ltd.co.uk

## Fax

01905 823 297

## AKW

Pointon Way, Hampton Lovett  
Droitwich Spa, WR9 0LR

[www.akw-ltd.co.uk](http://www.akw-ltd.co.uk)  
[orders.akw-ltd.co.uk](mailto:orders.akw-ltd.co.uk)

## Follow us on Social:



## Guarantee

The life time guarantee only applies to manufacturing or material defects, conditional on the one-time correct installation of the product and does not apply to blockages, inappropriate use or accidental damage. This does not cover damage or defects that result from incorrect installation, lack of maintenance including the build up of grime, dirt or lime-scale and waterborne debris, damage resulting from inappropriate cleaning or water ingress, damage from water freezing or extreme temperature changes. Damage or defects that result from repairs or modifications undertaken by unauthorised persons who are not maintenance engineers. This guarantee excludes general wear and tear through usage and does not apply to surface finish.

## What to do if something goes wrong?

In the event that you should encounter a problem with this product, please contact your local installer and if this does not resolve the issue, then contact AKW technical team who will provide further advice and, if necessary, arrange for a maintenance engineer to visit and report any issues. See the T&Cs on our website or in our catalogue for further information. None of the foregoing affects your statutory rights.